

***Reducing the hazards of high-level radioactive waste in Southern California:  
Storage of nuclear waste from spent fuel at San Onofre***



Robert Alvarez

Commissioned by Friends of the Earth  
June 25, 2013



# ***Reducing the hazards of high-level radioactive waste in Southern California: Storage of nuclear waste from spent fuel at San Onofre***

**By Robert Alvarez<sup>1</sup>**

## **Executive Summary**

Southern California Edison's decision to permanently shut down the San Onofre Nuclear Generating Station redefines the plant as a major radioactive waste storage site containing one of the largest concentrations of artificial radioactivity in the United States. These wastes are highly radioactive and will remain dangerous for tens of thousands of years. According to the U.S. Government Accountability Office, in testimony before the U.S. Congress in April, spent nuclear fuel is "considered one of the most hazardous substances on earth."<sup>2</sup>

Over the past 44 years, the San Onofre reactors generated about 926,836 spent fuel rods containing roughly 484 million curies of long-lived radioactivity. Of the estimated 1,631 metric tons of spent fuel at the site, about 1,099 tons is currently stored in two reactor pools. This is nearly three times more long-lived radioactivity than is stored in some 177 defense high-level radioactive tanks at the U.S. Department of Energy's Hanford site in Washington. A further 430 tons of spent fuel is contained in dry cask stores.

Approximately 43 percent of the intermediate and long-lived radioactivity in the spent nuclear fuel at SONGS is Cesium-137 (Cs-137). The reactors at San Onofre have generated about 210 million curies of Cs-137. Of that, about 168 million curies of Cs-137 are in the two spent fuel pools. By comparison, this quantity of Cs-137 is more than 6 times the amount released by all atmospheric nuclear weapons tests, and about 89 times that released by the Chernobyl accident.

According to estimates developed in 2007 for the Nuclear Regulatory Commission's Emergency Operation Center, an earthquake at SONGS might cause spent nuclear fuel pool drainage and lead to a catastrophic radiological fire. According to the document: "*The plant staff is calling you from San Onofre, Unit 2 because there has been an earthquake in the vicinity. The spent fuel pool has lost much of its water due to a large crack possibly flowing into a sink hole. . . .The spent fuel building has been severely damaged and is in many places directly open to the atmosphere.*"

Within 6 hours after the water is lost, spent fuel cladding would catch fire releasing approximately 86 million curies of radioactivity into the atmosphere. Of that about 30 percent of the radioactive cesium in the spent fuel (roughly 40 million curies) would escape into the air. This is 150 percent more than released by all atmospheric nuclear weapons tests. The resulting doses to people living within a 10-mile radius would be in the lethal range.

The pool fire would release far more radioactivity than a reactor meltdown. Far less radioactive cesium was released by the Fukushima nuclear disaster, which resulted in significant land and aquatic contamination, forcing the eviction of approximately 150,000 people from their homes, food restrictions, and the large, costly remediation of large areas offsite.

With a half-life of 30 years, cesium-137 gives off potentially dangerous penetrating radiation and is absorbed in the human food chain as if it were potassium. An area roughly two-thirds-the size of the

state of New Jersey still remains uninhabitable from Cs-137 released by the Chernobyl nuclear accident in 1986.

A major reason for this potential hazard is that the pools were meant to store irradiated nuclear fuel no longer than five years and not for indefinite storage of 4-5 times more than their original designs intended. Thus, U.S. spent nuclear fuel pools are not required to have “defense-in-depth” nuclear safety features as required for the reactors. Because they are not under the heavy containment that covers reactor vessels as is mandatory for all new reactors, radiation releases from spent pools are more likely to reach the outside environment.

By contrast the radiological consequences of a dry cask rupture are significantly less. According to the NRC, a cask rupture would result in the release of 2,500 times less radioactivity. It is therefore imperative that Southern California Edison should, before undertaking any other task involved in decommissioning the plant, move immediately to accelerate the safe transfer of remaining spent Cs-137 in the San Onofre cooling pools to on-site, dry-cask storage

Underscoring the NRC’s conflicting claims about spent fuel pool dangers, the U.S. District Court of Appeals vacated the NRC’s Waste Confidence Rule, which allows for high density pool storage. The court found that “the Commission failed to properly examine the risk of leaks in a forward-looking fashion and failed to examine the potential consequences of pool fires.”

According to the Electric Power Research Institute's estimates, it will cost approximately \$122 million (@ \$1 million each) for labor, canister and overpack construction to place all remaining spent nuclear fuel into dry casks at SONGS. SONGS already has an ongoing cask manufacturing operation located near the site, which can be scaled up. Removal of spent fuel older than 3-5 years can be done within 5 to 7 years. As of 2011, SONGS had placed 1,091 spent nuclear fuel assemblies in 42 casks, which are placed in thick-wall structures. It’s important to note that despite the significant destruction of the Fukushima nuclear site caused by a major earthquake and tsunami, all 9 dry spent fuel storage casks there were unscathed.

Wet storage operating costs do not factor in potential safety problems associated with age and deterioration of spent fuel pool systems, especially at closed reactors. In 2011 a study done for the U.S. Nuclear regulatory Commission by the Oak Ridge National Laboratory concluded:

*As nuclear plants age, degradations of spent fuel pools (SFPs), reactor refueling cavities, and the torus structure of light-water reactor nuclear power plants (NPPs) are occurring at an increasing rate, primarily due to environment-related factors. During the last decade, a number of NPPs have experienced water leakage from the SFPs [spent fuel pools] and reactor refueling cavities.*

It will be several decades before a permanent disposal site will be available, says the Energy Department, which estimates a permanent repository might open in 2048. Given that more than half a century has already passed in the quest for a permanent geological disposal site in the U.S., combined with a long history of failure in establishing centralized interim away from reactor storage, the State of California should be prepared for the real possibility that spent nuclear fuel will remain on site for decades to come.

There are funds already collected that can pay for this. The Nuclear Waste Policy Act established a user fee to pay 0.1 cent per kilowatt-hour to cover the search for and establishment of a high-level radioactive waste repository, but the law did not allow these funds to be used to enhance the safety of

onsite spent fuel storage. As of fiscal year 2011, only \$7.3 billion had been spent, leaving a balance of \$25 billion unspent. This sum could more than pay for the dry, hardened storage of spent reactor fuel older than five years at all reactors, if Congress amends the Nuclear Waste Policy Act of 1982.

Safely securing the spent fuel that is currently in crowded pools at reactors should be a public safety priority of the highest degree. The cost of fixing the nation’s nuclear vulnerabilities may be high, but the price of the status quo is far higher.

**THE SAN ONOFRE NUCLEAR WASTE INDEX**

Total amount of spent fuel on site : 1631 tons

Amount of spent fuel currently stored in pools: 1099 tons

Amount of spent fuel in dry casks : 430 tons

Number of spent fuel rods generated by 44 years of reactor operations: 926,836

Amount of radioactivity in the spent fuel rods: 484 million curies

Amount of spent fuel to be stored in cooling pools: about 73 percent

Number of times the radioactivity in SONGS's cooling pools exceeds that in 177 waste tanks at the notorious Hanford , Wash., site: nearly 3

Percentage of radioactivity in SONGS' waste that is Cs-137, the most risky form: 43

Number of times the radioactivity in Cs-137 at SONGS exceeds all that released in atmospheric nuclear weapons tests: 6

Number of times it exceeds that released at Chernobyl: 89

**Comparison of Cesium-137 Inventories  
(Curies)**

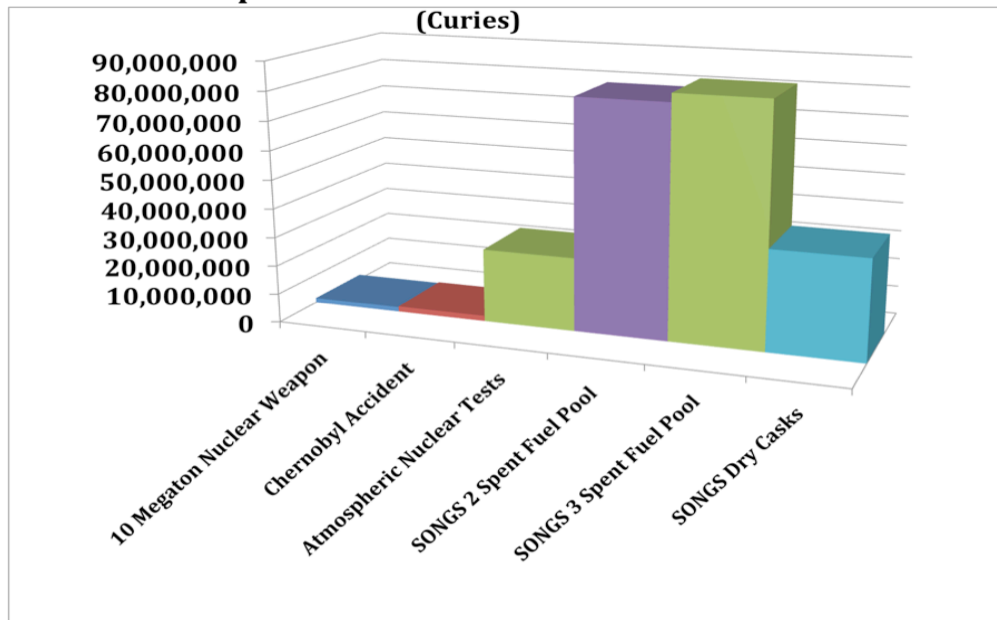

## Introduction

On June 7, 2013, Southern California Edison announced that it would abandon plans for the operation of San Onofre reactors unit 2 and unit 3 - bringing nuclear reactor operations at the site to an end after 45 years.<sup>3</sup> However, the radiological threat does not end with the end of reactor operations.

It will be several decades before a permanent disposal site will be available says the Energy Department's in its recent strategic plan to implement the Blue Ribbon Commission recommendations. DOE calls for a permanent repository to open in 2048. Given that more than a half century already passed in the quest for a permanent geological disposal site in the U.S., the State of California should be prepared for the real possibility that spent nuclear fuel will remain on site for decades to come.

This report addresses the potential risks of spent nuclear fuel storage at the San Onofre Nuclear Station (SONGS). Over the past 44 years, the SONGS reactors have generated about 926,836 spent fuel rods containing roughly 484 million curies of radioactivity from more than 50 intermediate and long-lived radioisotopes. A total of about 1,631 tons of spent fuel is located at the site with about 1099 tons currently stored in two reactor pools. The spent fuel from reactor unit 3 is to be moved to pools during the remainder of 2013, bringing the total tonnage in pools to 1,201 tons. Currently, 430 tons of spent fuel is contained in dry cask stores. Thus within a matter of months, 73% of all spent fuel on site will be water filled storage pools.

Operated by South California Edison (SCE), SONGS is located in San Diego County. The reactors and related facilities occupy approximately 214 acres within the boundaries of the Camp Pendleton U.S. Marine base leased by the U.S. Government. The site is located alongside San Onofre State Beach and is parallel to the San Diego Freeway (I-5) (See Figure 1).

On June 7, 2013 SCE announced that it planned to permanently cease operations of the two Pressurized Water Reactor (PWR) units (Unit 2 and 3), which were started up in 1983 and 1984- each with an installed capacity of 1,172 and 1,178 Megawatts (MWe). Unit 1, a 1347 MWe PWR began operation in 1968 and was permanently shut down in 1992 (See Figure 1). The remaining decommissioning activities at Unit 1 are not scheduled to be finished until December 2030. The timelines for decontamination and decommissioning of Units 2 and 3 have yet to be spelled out.

Approximately 8.7 million people live within a 50-mile radius of the SONGS site,<sup>4</sup> with many millions more within the 100 to 200 mile range.

**Figure 1. San Onofre Nuclear Generating Station**



In a PWR, the energy from the irradiated fuel core transfers from the reactor's cooling system, which consists of the reactor vessel, steam generators, coolant pumps and connecting piping. The SONGS 2 and 3 units were designed by Combustion Engineering Co. Each reactor has two steam generators, four reactor coolant pumps and a pressurizer (See Figure 2).

Unlike other forms of electrical generation, nuclear power reactors pose extraordinary radiological risks from the release of large inventories of radioactive elements. The inventories are initially generated by the irradiation of uranium fuel in the reactor. After 24 months, the amount of uranium-235 that provides enough fissioning to generate energy from the fuel is depleted, while creating a large amount of radioactivity in the spent fuel.

As demonstrated by the 2011 Fukushima Dai-Ichi nuclear power accident in Japan, the release of radioactivity into the environment has created significant land and aquatic contamination—resulting in evacuation of approximately 150,000 people, food restrictions, and a large, costly and uncertain stabilization of the reactor site and remediation of large areas offsite.

**Figure 2. The SONGS Reactor Design**

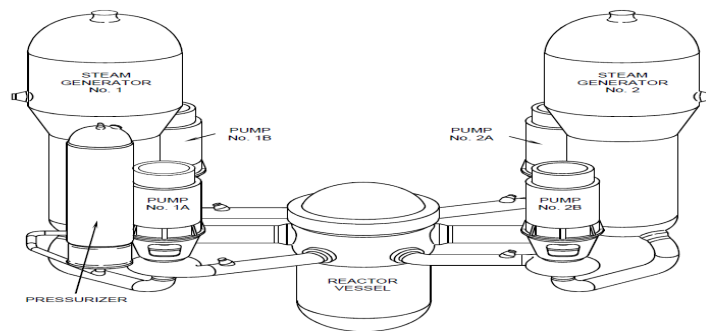

*Source: NRC Reactor Concepts Manual*

Roughly 68 square-miles (175 sq km) of land are contaminated with cesium-137 in regions where people remain evacuated from the 1986 Chernobyl accident.<sup>5</sup> Approximately 695 square-miles (1,800 sq km) of land within the Fukushima Prefecture is contaminated at levels resulting in annual exposures more than 30 times allowed for the American public by the U.S. Environmental Protection Agency.<sup>6</sup> The long-term human and ecological impacts of the Fukushima nuclear accident have yet to play out.

### **Spent Nuclear Fuel**

The importance of safe and secure storage of spent power reactor spent fuel has grown commensurate with its accumulation at the San Onofre Nuclear Generating Station. Spent fuel pools at nuclear reactors contain a substantially larger inventory of irradiated fuel than the reactors. The SONGS Unit 3 core contains about 83 metric tons (SONGS 3 has been recently defueled).<sup>7</sup> Unit 2 holds about 102 metric tons which have yet to be removed.<sup>8</sup> SONGS Units 2 and 3 pools contain 514 and 585 metric tons respectively.<sup>9</sup> There are 42 dry casks at SONGS holding about 430 metric tons. The irradiated fuel core in SONGS Unit 2 has yet to be removed and contains about 102 metric tons (See Table 1).

Over the past 45 years (1968-2013), SONGS has generated about 1,631 metric tons of spent nuclear fuel contained in 4,021 assemblies<sup>10</sup> holding 926,836 rods. The rods contain approximately 484 million curies (1.79 E+19 Bq) of intermediate and long-lived radioactive elements.<sup>11 12</sup> This is nearly three times than in some 177 defense high-level radioactive tanks at the U.S. Department of Energy's Hanford site in Washington.<sup>13</sup>

High-density spent fuel pool storage at SONGS has long reached its maximum capacity.<sup>14</sup> Approximately 70 percent of the spent nuclear fuel at SONGS is stored in pools at units 2 and 3, while the rest is stored in dry casks (See table 1).<sup>15</sup> Motivated by economics, the government and the private corporations that own the nation's nuclear reactors have treated the storage of spent fuel as an afterthought for years. They presumed that a safer system for disposal would be established no later than 1998, as mandated by the 1982 Nuclear Waste Policy Act. Before President Obama terminated the Yucca Mountain disposal project, which was slated to open in 2020, the opening date had slipped by over two decades.

In 1982, after embarrassing failures by the Atomic Energy Commission (the predecessor of the Nuclear Regulatory Commission and the Energy Department) to select a disposal site on its own, Congress enacted the Nuclear Waste Policy Act, which began the selection process for multiple sites throughout the United States. This process was scrapped five years later due to eastern states derailing the selection process. Congress then voted to make Yucca Mountain in Nevada the only site to be considered. Yet Yucca's proposed opening date slipped by more than 20 years as the project encountered major technical hurdles and fierce local and state opposition.

U.S. spent nuclear fuel pools are not required to have “defense-in-depth” nuclear safety features. They are not under the heavy containment that covers reactor vessels. Reactor operators are not required to have redundant back-up power supplies to circulate water in the pools and keep them cool, if there is a loss of off-site power. In the recent past some U.S. reactor control rooms lacked instrumentation keeping track of the pools' water levels. At one reactor, water levels dropped to a potentially dangerous level after operators failed to bother to look into the pool area. Some reactors may not have necessary water restoration capabilities for pools. Quite simply, spent fuel pools at nuclear reactors are not required to have the same level of nuclear safety protection as reactors.

### Characteristics of Spent Nuclear Fuel

As uranium fuel is irradiated in a reactor core at SONGS radioactive elements are created when the atoms of uranium-235 and other heavy isotopes are split (fission) as well as by absorption (activation) of neutrons in the atoms of many other isotopes. The fuel is enriched above its naturally-occurring fraction of 0.7 percent of U-235 to as much as 4.8 percent at SONGS so it can serve as the primary isotope needed for fission and thus, the generation of energy.

**Table 1**

<b>Indicator</b>	<b>San Onofre 1</b>	<b>San Onofre 2</b>	<b>San Onofre 3</b>
Rated power of reactor	1,347 MW(t)	3,438MW(t)	3,438MW(t)
Number of fuel rods per assembly	180	236	236
Number of assemblies in reactor core	Reactor closed	Reactor Closed	217 (To be defueled in the near future.)
Typical period of full-power exposure of a “lead” fuel assembly (assuming refueling outages of 2-month duration at 24-month intervals, discharging 72 assemblies, capacity factor of 0.9 between outages)	N/A	6 years	6 years
Typical burn-up of fuel assembly at discharge	41,200 MWt-days	50,000MWt-days	50,000 MWt-days
Typical Cs-137 inventory in fuel assembly at discharge	N/A	0.116 MCi	0.116 MCi
Cs-137 inventory in reactor core	N/A	Reactor Defueled	25.22MCi



Capacity in spent fuel pool	N/A	1,325	1,325
Number of assemblies pools	N/A	1,486	1,227
Number of assemblies in dry casks	395	348	348
Cs-137 inventory in spent fuel pool (assuming space for full core unloading. Average of assembly age after discharge =23 years for SONGS 1 and 10 years for SONGS 2 and 3.	N/A	83.03M Ci	M Ci
Cs-137 Inventory in a dry storage cask (24 assemblies per cask)	0.85 M Ci	83M Ci	86 M Ci
Total Cs-137 inventory in dry casks	13.4 M Ci	12.8 M Ci	12.8 M Ci

Some 400 pellets made of slightly enriched ceramic uranium dioxide (UO<sub>2</sub>) are stacked in zirconium metal alloy tubes and sealed at both ends. The gap between the rods and pellets of approximately 152 micrometers is filled with helium to a pressure of 10 bar or 145 pounds per square inch. Thickness of the rod cladding is between 0.04-0.8 mm (0.00157 to 0.00314 inches)<sup>16</sup> –15 to 30 times less than a computer disc (CD/DVD)<sup>17</sup> and slightly thicker than aluminium foil used in kitchens.<sup>18</sup>

At SONGS 236 rods are fitted into a long rectangular-shaped assembly approximately 13.3 feet long and 8 inches across. The rods are held in the assembly by an end plate, a structural guide tube, a spacer grid and end fitting. All told there are some 20 million fuel pellets in a fuel core for each of the SONGS 2 and 3 reactors.<sup>19</sup> (See Figure3 )

The assemblies spend as long as 6 years undergoing irradiation<sup>20</sup> and are replaced with fresh fuel when the reactors are shut-down every two years.

When the reactor is shut down, the spent fuel being removed contains a myriad of radioactive isotopes with different half-lives including longer lived radioisotopes, notably cesium- 137 (half-life=30 years), along with very long-lived fission products (i.e. iodine-129, Technetium-99, Cs-135) and actinides (plutonium-239, americium-241) that have half-lives ranging from tens of thousands to millions of years.

### **Radioactivity of Spent Nuclear Fuel**

Spent fuel contains materials that are radiotoxic meaning that they create biological damage based on their radioactive properties alone. The most immediate and severe form of harm is direct exposure to a spent nuclear fuel assembly at a near distance. For instance, a freshly discharged spent fuel assembly at SONGs would give off more than 10,000 rems per hour (100 Sv/hr) in the form of external penetrating radiation.<sup>21</sup> A person standing within 3 feet of this assembly would receive a lethal dose within minutes. For the next 100 years, it would give off life threatening doses at this distance.<sup>22</sup> Long-term damage from lower doses includes cancers, other diseases, and lasting genetic damage, including congenital abnormalities, chromosomal disorders, and range of diseases, which could span generations.<sup>23</sup>

From the perspective of public safety, the cesium-137 content in spent fuel at SONGS is an important radioisotope of concern. With a half-life of 30 years, Cs-137 gives off external penetrating radiation as it decays and accumulates in living organisms as if it were potassium. According to the National Council on Radiation Protection and Measurements (NCRP), “Cs -137 has often proven to be the most important long-term contributor to the environmental radiation dose received by humans and other organisms as a result of certain human activities.<sup>24</sup>” As the reactor accidents at Chernobyl, in the Ukraine in 1986 and the Fukushima Dai-Ichi site in Japan last year, large-scale environmental contamination by Cs-137 underscores this concerns.

**Figure 3**

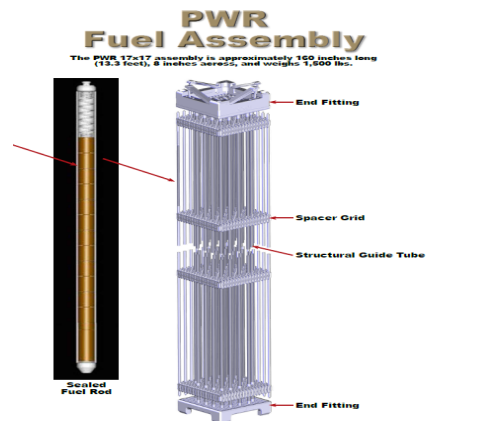

*Source: U.S. Department of Energy, DOE/EIS-0283-S-2, July 2012.*

Approximately 43 percent of the intermediate and long-lived radioactivity in the spent nuclear fuel at SONGS is Cs-137. Thus, the reactors at San Onofre have generated about 210 million curies (1.43E+19 Bq) of Cs-137. Of that, about 168 million curies of Cs-137 are in the two spent fuel pools. By comparison, this quantity is more than 6 times the amount released by all atmospheric nuclear weapons tests, and about 89 times that released by the Chernobyl accident.<sup>25</sup> ( See figure 4).

### **Decay Heat**

After removal, the spent fuel gives off a significant amount of heat as the radioisotopes decay. The offload of a full reactor core at SONGS is estimated to give off about 42,000 BTU/hr (12,310 watts).<sup>26</sup> Within one year the heat output of the spent fuel diminishes by about ten times. After 10 years it drops by another factor of ten. By 100 years the decay heat has dropped another five times, but still gives off significant heat.<sup>27</sup> However, the decay heat remains substantially high throughout the operation of the reactors and well after they are closed.

Control of decay heat is a key safety factor for spent fuel storage and its final disposal in a geological repository. Storage of spent nuclear fuel in pools requires continuous cooling for an indefinite period to prevent decay heat from igniting the zirconium cladding and releasing large amounts of radioactivity into the environment.

Zirconium cladding of spent fuel is chemically very reactive in the presence of uncontrolled decay heat. According to the National Research Council of the National Academy of Sciences the build up of decay heat in spent fuel in the presence of air and steam:

“ is strongly exothermic – that is, the reaction releases large quantities of heat, which can further raise cladding temperatures... if a supply of oxygen and or steam is available to sustain the reactions.. The result could be a runaway oxidation – referred to as a *zirconium cladding fire* – that proceeds as a burn front (e.g., as seen in a forest fire or fireworks sparkler)..As fuel rod temperatures increase, the gas pressure inside the fuel rod increases and eventually can cause the cladding to balloon out and rupture.[original emphasis] ”<sup>28</sup>

The Nuclear Regulatory Commission (NRC) has performed several studies to better understand this problem. In 2001, the NRC concluded:

“... it was not feasible, without numerous constraints, to establish a generic decay heat level (and therefore a decay time) beyond which a zirconium fire is physically impossible.”<sup>29</sup>

In terms of geologic disposal, decay heat, over thousands of years, can cause waste containers to corrode, negatively impact the geological stability of the disposal site and enhance the migration of the wastes.<sup>30</sup> At the now-cancelled Yucca Mountain geological disposal site in Nevada decay heat from spent fuel would require approximately 2,500 cubic feet of storage space and ventilation, for each cubic foot of spent fuel.<sup>31</sup>

### **High Burnup Nuclear Fuel**

For some 16 years, U.S. reactor operators, including Southern California Edison, have been permitted by the NRC to double the amount of time nuclear fuel can be irradiated in a reactor, by approving an increase in the percentage of uranium-235, the key fissionable material that generates energy. In doing so, NRC has bowed to the wishes of nuclear reactor operators, motivated more by economics than spent nuclear fuel storage and disposal.

In 2012 the National Academy of Engineering of the National Academy of Sciences raised concern about the viability of high-burnup fuel by noting, “the technical basis for the spent fuel currently being discharged (high utilization, burnup fuels) is not well established... the NRC has not yet granted a license for the transport of the higher burnup fuels that are now commonly discharged from reactors. In addition, spent fuel that may have degraded after extended storage may present new obstacles to safe transport.”<sup>32</sup>

Known as increased “burnup” this practice is described in terms of the amount of electricity in megawatts (MW) produced per day with a ton of uranium. As of 2008, the NRC allows reactors using uranium fuel to operate at the highest burnup rates of any country in the world.<sup>33</sup>

In October 1996, the NRC approved a license amendment permitting the SONGs Units 2 and 3 to increase burnup. by increasing fuel enrichment to 4.8 weight percent of uranium-235. <sup>34</sup> This allows a fuel assembly to remain as long as six years in the reactor core and for shutdowns for refueling to be extended from one to two years. San Onofre Units 2 and 3 are permitted to reach 62,000MTD/t but typically operate at a burnup level of 50,000 MDW/t.

Even NRC admits, “There is limited data to show that the cladding of spent fuel with burnups greater than 45,000 MWd/MTU will remain undamaged during the licensing period.” <sup>35</sup>

In allowing increased burnup at power reactors the NRC has taken a leap of faith with respect to the safe operation of reactors and the storage and disposal of spent nuclear fuel. With higher burn up, nuclear fuel rods undergo several risky changes that include:

- Increasing oxidation, corrosion and hydriding of the fuel cladding. Oxidation reduces cladding thickness, while hydrogen (H<sub>2</sub>) absorption of the cladding to form a hydrogen-based rust of the zirconium metal from the gas pressure inside the rod can cause the cladding to become brittle and fail;<sup>36</sup>
- Higher internal rod gas pressure between the pellets and the inner wall of the cladding leading to higher fission gas release. Pressure increases are typically two to three times greater.<sup>37</sup>
- Elongation or thinning of the cladding from increased internal fission gas pressure;<sup>38</sup>
- Structural damage and failure of the cladding caused by hoop (circumferential) stress;<sup>39</sup>
- Increased debris in the reactor vessel, damaging and rupturing fuel rods;<sup>40</sup>
- Cladding wear and failure from prolonged rubbing of fuel rods against grids that hold them in the assembly as the reactor operates (grid to rod fretting).<sup>41</sup>
- A significant increase in radioactivity and decay heat in the spent fuel.<sup>42</sup>
- A potentially larger number of damaged spent fuel assemblies stored in pools<sup>43</sup>
- Upgraded pool storage with respect to heat removal and pool cleaning.<sup>44</sup>
- Requiring as much as 150 years of surface storage before final disposal.<sup>45</sup>

There is growing evidence that as a result of higher burn-ups nuclear fuel cladding cannot be relied upon as a primary barrier to prevent the escape of radioactivity, especially during dry storage. This has not been lost on the nuclear industry and staff of the NRC for several years now. Damage in the form of pinhole leaks, and small cracks that could lead to breaching of fuel cladding is “not explicitly defined in [NRC] Regulations, staff guidance or standards.”

### **Fuel Rod Damage and Failures**

Failure of nuclear fuel rods in which the cladding is breached from grid to rod fretting has been a problem for nearly 20 years and remains the primary cause of fuel rod failures for pressurized water reactors, such as those at SONGS. As a result of prolonged vibration and high volume water flow inside the reactor during the fissioning process, fuel cladding that encases the fuel pellets wears out and ruptures from rubbing against the grids that hold them in place “Grid-to-rod fretting (GTRF) is the predominant fuel failure mechanism in U.S. pressurized water reactors, accounting for more than 70% of failures since 2000, or about 40 failed assemblies per year, the Electric Power Research Institute (EPRI) recently concluded.<sup>46</sup> (See figure 5). EPRI finds that Combustion Engineering designed reactors, such as those at SONGS “are known to be more challenging for GTRF [grid-to-rod failure] resistance.”<sup>47</sup>

According to the NRC in 2011, the San Onofre Nuclear Generating Station “continues to experience grid-to-rod fretting failures and remains one of the small number of plants unable to meet the Institute of Nuclear Power Operations’ current goal for fuel performance.”<sup>48</sup> In 2008, the SONGS Unit 3 discovered 15 such fuel rod failures after one irradiation cycle.<sup>49</sup> Based on EPRI’s estimate cited above, the San Onofre Unit 3 was responsible for about 38 percent of all grid-to-rod fuel failures at U.S. nuclear power plants that year. SCE was seeking to amend its

license so that SONGS Units 2 and 3 can utilize High Thermal Performance fuel rods made by the French company, Areva, as an alternative to the costly redesign of its fuel cores. According to SCE, this problem significantly hampers efforts to extend irradiation times and thus, increased electrical output.<sup>50</sup>

**Figure 5. Grid-to-Rod failure**

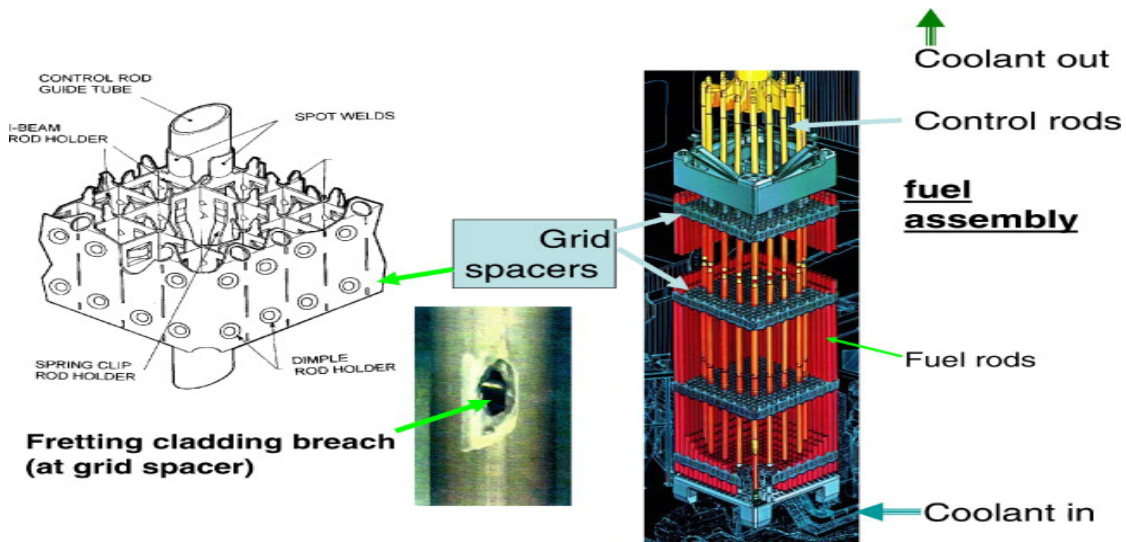

Source: Google Images

### Spent Nuclear Fuel Pools at SONGS

Spent reactor fuel pools serve to cool irradiated fuel assemblies, and provide shielding from the enormous amount of radioactivity generated as a by-product of producing electricity. For these reasons the spent nuclear fuel must be covered with at least 10 feet of water at all times.<sup>51</sup>

Like all other reactors in the U.S. the spent fuel pools at SONGS are not required to be placed under thick containment as are the reactors. Nor does the NRC require operators to have emergency back-up power generators to maintain pool cooling or water make-up capabilities that can survive earthquakes or floods. The spent fuel pools at SONGS also share potentially vulnerable water cooling systems required for the ultimate source of cooling in case the primary systems fail. Thus, radiation releases from spent pools are more likely to reach the outside environment.

Each SONGS reactor has a separate spent fuel pool (SNP). The pool is located in the fuel handling building adjacent to the reactor. The building is a seismic category I reinforced concrete structure. The pools are located above grade with a pool elevation of 17.5 feet, with<sup>52</sup> reinforced concrete structures lined with a 3.16" (80.23 mm) thick stainless steel welded liner plate. The operating deck of the pools is located at 63.5 feet elevation of the fuel handling building. As of the end of 2001, SONGS unit 1 pool contained about 80 percent of its storage capacity, while Unit 2 reached 82 percent of its pool storage capacity. With this amount of SNF the water volume in the pools are approximately 350,000 gallons. The spent nuclear fuel pool system involves three connected areas separated by gates and seals (See figure 6).

1. The spent fuel pool itself contains storage racks divided into two regions. Region 1 contains 312 stainless steel storage cells spaced 10.4 inches apart surrounded by neutron absorbing panels. It is used generally for holding new unirradiated fuel and temporary storage of freshly discharged irradiated fuel. Region 2 holds 1,230 storage cells surround with neutron absorbing panels with an inside dimension of 8.63 inches. The pool and racks are flooded with boronated water (1,850 ppm). This region is used for longer term storage. The cask storage pool is used primarily for fuel loading or transportation casks.
2. A transfer pool, a smaller area is used during refueling; and.
3. The Refueling Canal or cavity is connected by the transfer tube. This part of the pool system is used to discharge spent fuel or to refuel the reactor with fresh fuel. It is drained following these functions.

The spent fuel cooling system at the SONGS Units 2 and 3 removes decay with two pumps that service two heat exchangers.

Certain components of the spent fuel pool system necessary to provide make-up water following an earthquake are not seismically hardened. According to an engineering evaluation done by SCE, in October 2010, “

“(SONGS) Units 2 and 3 were periodically operated with the safety-related Seismic Category I (SC-I) Refueling Water Storage Tank (RWST) aligned to the nonsafety-related non-seismic purification loop piping in the Spent Fuel Pool Cooling and Cleanup System, potentially resulting in a loss of safety function.”<sup>53</sup>

The pools were originally designed to serve as short term storage for a period of five years before the fuel was removed for longer-term storage and reprocessing. “Neither the AEC [Atomic Energy Commission, now the Energy Department] nor utilities anticipated the need to store large amounts of spent fuel at operating sites,” said a report by Dominion Power, the owner of the Millstone nuclear reactor in Waterford, Connecticut in October 2001. “Large-scale commercial reprocessing never materialized in the United States. As a result, operating nuclear sites were required to cope with ever-increasing amounts of irradiated fuel... This has become a fact of life for nuclear power stations.”<sup>54</sup>

Higher burn up increases decay heat substantially which places greater stress on the pool cooling and cleaning/filtration system at SONGS. There are no NRC-required safety specifications for the pool heat exchangers when the reactor is defueling high heat spent fuel. The pools at SONGS are cooled by the Component Cooling Water (CCW) System. The CCW system provides cooling to components such as the Reactor Coolant Pump motors and seals. In 2007, the spent fuel cooling system lost its safety function when both Unit 2 spent fuel pool cooling pumps were inoperable because of excessive decay heat from an offload of spent fuel.<sup>55</sup> SEC failed to report this to the NRC for two years. Moreover, debris possibly from the spent fuel pools was suspected to have clogged the heat exchanger shared by the Salt Water Cooling (SWC) system, causing a reduction in flow of the SWC.

The Salt Water Cooling system (SWC) provides the ultimate heat sink from the ocean for the reactors in case of an event that cripples the site’s primary cooling systems. During shutdown the SWC system also provides cooling for safety-related components. According to the NRC,

“the ultimate heat sink complex serving multiple units should be capable of providing sufficient cooling water to permit simultaneous safe shutdown and cool down of all units it serves and to maintain them in a safe shutdown condition.”<sup>56</sup>The ultimate heat sink removes heat from the reactor after shutdown and during accidents, as was the case at the Fukushima Dai-Ichi site.

SCE and the NRC apparently consider these events as having minor safety significance. However, they underscore the lack of safety priority for spent fuel storage and even more significantly, a potential vulnerability associated with the spent fuel pool and the ability of the reactors to maintain an ultimate heat sink during a major accident.

### **Deterioration of Spent Fuel Pool Equipment**

High-density racks in spent fuel pools at SONGS pose potential criticality safety concerns associated with the deterioration of neutron absorbing panels that allow spent fuel rods to be more closely packed. Since 1983, several incidents have occurred at reactors around the U.S. with these panels in which the neutron-absorbing materials deteriorated, and in some cases, bulged, causing spent fuel assemblies, containing dozens of rods each, to become stuck in submerged storage racks in the pools. This problem could lead to structural failures in the storage racks holding the spent fuel rods in place.

According to the NRC in May 2010:

The conservatism/margins in spent fuel pool (SFP) criticality analyses have been decreasing...The new rack designs rely heavily on permanently installed neutron absorbers to maintain criticality requirements. *Unfortunately, virtually every permanently installed neutron absorber, for which a history can be established, has exhibited some degradation. Some have lost a significant portion of their neutron absorbing capability. In some cases, the degradation is so extensive that the permanently installed neutron absorber can no longer be credited in the criticality analysis* [emphasis added].<sup>57</sup>

In 2007, South California Edison (SCE) reported to the NRC that Boraflex neutron absorbing panels have deteriorated to the point at the SONGS Units 2 and 3 spent nuclear fuel pools where it was doubtful they could be credited to prevent criticality. SCE proposed installing borated stainless steel tube guide inserts, and to add more neutron absorbing boron to the pool water.<sup>58</sup> According to SCE deterioration from erosion, over a period of 15 months, increased the level of particles from disintegrated neutron absorbing panels in the pool water by 134 percent.<sup>59</sup> These particles place an additional strain on pool water cleaning systems.

Equipment installed to make high-density pools safe exacerbates the danger of spent fuel cladding ignition, particularly with aged spent fuel. In high-density pools at pressurized water reactors, fuel assemblies are packed about nine to 10.5 inches apart, just slightly wider than the spacing inside a reactor. To compensate for the increased risks of a large-scale accident, such as a runaway nuclear chain reaction, pools have been retrofitted with enhanced water chemistry controls and neutron-absorbing panels between assemblies.

The extra equipment restricts water and air circulation, making the pools more vulnerable to systemic failures. The ability to remove decay heat from spent fuel pools to prevent boiling corresponds to the amount of water displaced in the pool by spent fuel and the equipment that

allows for its tight packing. High density storage also impacts the ability of water to flow through the pool. If the equipment collapses or fails, as might occur during a destructive earthquake or terrorist attack, air and water flow to exposed fuel assemblies would be obstructed, causing a fire, according to the NRC's report. Heat would turn the remaining water into steam, which would interact with the zirconium, making the problem worse by yielding inflammable and explosive hydrogen.

### Dry Cask Storage at SONGS

As of May 2011, the San Onofre Nuclear Station placed 42 dry casks in its Independent Spent Fuel Storage Installation (ISFSI) under license with the NRC. Six additional casks were expected to be loaded in the summer of 2011. The dry casks are all of Unit 1 spent fuel and Greater than Class C Waste (CTCC) from reactor decommissioning have been loaded into 17 canisters. Units 2 and 3 have each have loaded spent fuel into 12 casks.<sup>60</sup> Each canister holds a maximum of 24 spent fuel assemblies storing approximately 87 million curies of intermediate and long-lived radioisotopes.<sup>61</sup> The casks are placed on two pads. According to the NRC, "The ISFSI...has 9 canisters containing 27 Unit 1 failed fuel assemblies..., 4 canisters containing 46 Unit 2 failed fuel assemblies... and 2 canisters containing 22 Unit 3 failed fuel assemblies."<sup>62</sup> This indicates that about 10 percent of the spent fuel rod assemblies in dry casks have leaking and/or ruptured fuel cladding.

The San Onofre Nuclear Station uses the NUHOMS-24p dry casks system in which casks have a thicker design than other casks and are horizontally placed into a concrete-walled storage module to provide shielding from radiation and to protect the spent fuel from the marine environment. (See figure 6). The roof of the canister storage module is five feet thick. Unlike other reactor sites, SONGS had a canister fabrication shop located on the mesa across the highway from the ISFSI. As of May 2011 the shop was in the process of fabricating new canisters.

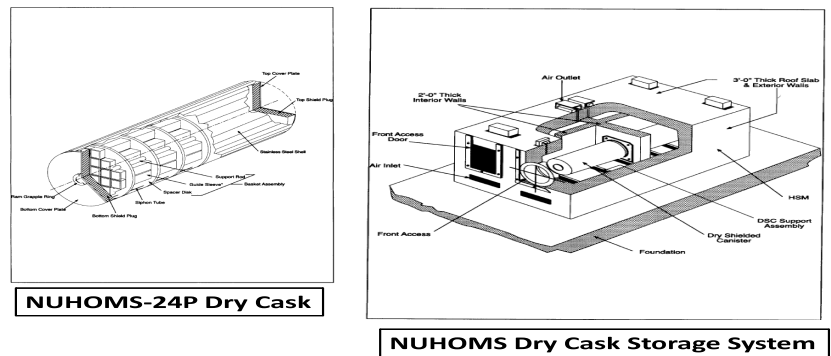

Source: NUREG-1571

Figure 6

According to the NRC, "the seismic design of the Advanced NUHOMS storage system exceeded the postulated earthquake conditions that could occur at the SONGS site....The ISFSI was located 19.75 feet above sea level. A flooding condition was assumed to reach elevation 29 feet, resulting in 9 feet of water on the pad. This was less than the 50 feet of water evaluated in



Section 2.2.2 of the FSAR for the design basis flood.”<sup>63</sup> However, additional evaluations are underway to determine if current seismic parameters are protective at SONGS. Also, the Final Safety Analysis Report which defines the “safety envelope” for the ISFSI does not include an accident analysis for a situation where the canister is filled with water after the lid is welded in place, with the closed ventilation and a pressure build-up in the canister.<sup>64</sup>

### Consequences of a Spent Fuel Pool Fire at a Nuclear Reactor

For the past 30 years, nuclear safety research has consistently pointed out that severe accidents could occur at spent fuel pools resulting in catastrophic consequences. A severe pool fire could render about 188 square miles around the nuclear reactor uninhabitable, cause as many as 28,000 cancer fatalities, and spur \$59 billion in damage, according to a 1997 report for the NRC by Brookhaven National Laboratory done for the NRC.<sup>65</sup>

If the fuel were exposed to air and steam, the zirconium cladding would react exothermically, catching fire at about 800 degrees Celsius. Particularly worrisome is the large amount of cesium-137 in spent fuel pools, which contain anywhere from 20 to 50 million curies of this dangerous isotope. With a half-life of 30 years, cesium-137 gives off highly penetrating radiation and is absorbed in the food chain as if it were potassium.

The damage from a large release of fission products, particularly cesium-137, was demonstrated at Chernobyl. More than 100,000 residents from 187 settlements were permanently evacuated because of contamination by cesium-137. The total area of this radiation-control zone is huge: more than 6,000 square miles, equal to roughly two-thirds the area of the State of New Jersey. During the following decade, the population of this area declined by almost half because of migration to areas of lower contamination (Figure 7).

Figure 7

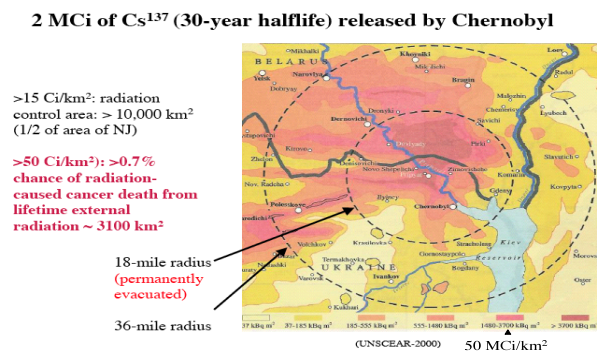

### 2003 Study

In the summer of 2002, the Institute for Policy Studies helped organize a working group including experts from academia, the nuclear industry, former government officials, and non-

profit research groups to perform in in-depth study of the vulnerabilities of spent power reactor fuel pools to terrorist attacks. By January 2003, our study was completed and accepted for publication in the peer-review journal *Science and Global Security*.<sup>66</sup>

We warned that U.S. spent fuel pools were vulnerable to acts of terror. The drainage of a pool might cause a catastrophic radiation fire, which could render an area uninhabitable much greater than that created by the Chernobyl accident (Figure 8).<sup>67</sup>

Figure 8

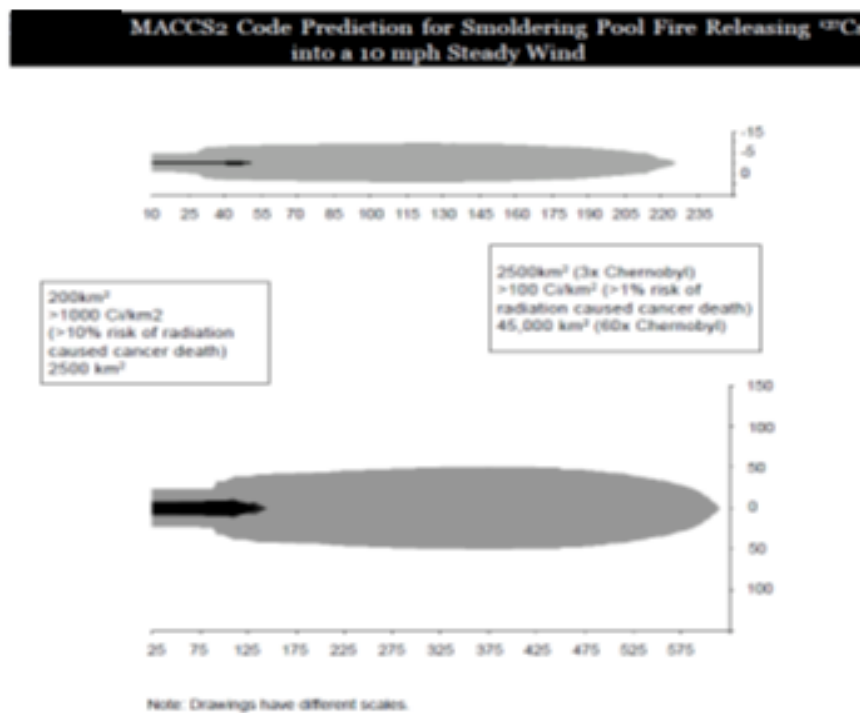

In addition to terrorist acts, there are several events that could cause a loss of pool water, including leakage, evaporation, siphoning, pumping, aircraft impact, earthquake, the accidental or deliberate drop of a fuel transport cask, reactor failure, or an explosion inside or outside the pool building. Industry officials maintain that personnel would have sufficient time to provide an alternative cooling system before the spent fuel caught fire. But if the water level dropped to just a few feet above the spent fuel, the radiation doses in the pool building would be lethal — as was demonstrated by the loss of water in at least two spent fuel pools at the Fukushima Dai-ichi nuclear power station.

The NRC and nuclear industry consultants disputed the paper, which prompted Congress to ask the National Academy of Sciences to sort out this controversy.

In 2004, the Academy reported that U.S. pools were vulnerable to terrorist attack and to catastrophic fires. According the Academy:

“A loss-of-pool-coolant event resulting from damage or collapse of the pool could have severe consequences...It is not prudent to dismiss nuclear plants, including spent fuel storage facilities as undesirable targets for terrorists...under some conditions, a terrorist attack that partially or completely drained a spent fuel pool could lead to a propagating zirconium cladding fire and release large quantities of radioactive materials to the environment...Such fires would create thermal plumes that could potentially transport radioactive aerosols hundreds of miles downwind under appropriate atmospheric conditions.”<sup>68</sup>

The NRC's response was to withhold the Academy's report, and issue its own analysis which disputed the report's findings. William Colglazier, executive officer of the academy said the NRC's response was misleading and warned that the public needed to learn about the report's findings. According to Colglazier, “There are substantive disagreements between our committee's views and the NRC. If someone only reads the NRC report, they would not get a full picture of what we had to say.”<sup>69</sup> Eventually a declassified version of the panel's report was made available.

### **Estimating the Consequences at SONGS**

As an important part of its preparedness and response capabilities, the NRC emergency operations center relies on a computer code to provide a rapid evaluation of the radiological impacts from accidents at nuclear power plants, spent fuel storage pools and casks. This code is a key element in deployment of emergency responders and evacuation of people within and beyond the NRC's 10-mile radius Emergency Planning Zone (EPZ). Known as the Radiological Assessment System for Consequence Analysis (RASCAL 3.0.5), this system provides projections for atmospheric releases and off-site radiation doses.<sup>70</sup> The instructional workbook for the RASCAL system provides an assessment of the consequences of a spent fuel pool fire at the San Onofre Unit 2 reactor, following a destructive earthquake. According to the workbook:

*“ The plant staff is calling you from San Onofre, Unit 2 because there has been an earthquake in the vicinity. The spent fuel pool has lost much of its water due to a large crack possibly flowing into a sink hole. Due to a malfunctioning pump, it has not been possible to provide enough water to make up for the loss. The water dropped to the top of the fuel at 8:49 A.M., and appears likely to continue dropping. Estimates are that the fuel will be fully uncovered by 11:00 A.M. The pool has high density racking and contains one batch of fuel that was unloaded from the reactor only 2 weeks earlier. (A batch is defined as one-third of a core) Another batch was unloaded about a year before that, and 8 batches have been in the pool for longer than 2 years. The spent fuel building has been severely damaged and is in many places directly open to the atmosphere.”<sup>71</sup>*

Based on this scenario, developed in 2007 for the NRC's Emergency Operation Center, within 6 hours of the pool drainage the spent fuel cladding would catch fire releasing approximately 86 million curies into the atmosphere. Of that about 30 percent of the radio-caesium in the spent

fuel (roughly 40 million curies) would be released – more than released by all atmospheric nuclear weapons tests.<sup>72</sup>

The resulting doses to people within 1, 5 and 10 miles of the release are calculated at 5,200, 1,200 to 450 rems respectively. These are considered to be life-threatening doses. Thyroid doses from inhalation of radioiodine are calculated at 39,000, 1,200 and 450 rems respectively. Doses from exposure to radioactive iodine would be enough to cause this organ to be destroyed (See Table 2)

The RASCAL Code underscores that within the 10-mile EPZ, it is clear that radiological hazards at greater distances of 25 to hundreds of miles for millions of people could be very serious. It also suggests that an area within the ten mile radius encompassing 314 square-miles of land and off-shore waters could be lethally contaminated.

**Table 2**

To atmosphere	86,000,000 curies		
	1 mile	5 miles	10 miles
Total Estimated Dose Equivalent (rem)	5,200	1,200	450
Thyroid Committed Dose Equivalent (rem)	39,000	8,900	3,500

*Source: NUREG-1889*

Within the 10-mile evacuation zone mandated by the NRC there are hundreds of thousands of residents and visitors, including:

- A large portion of the 125,000-acre U.S. Marine Camp Pendleton base where 64,000 troops and civilians live and work.<sup>73</sup>
- The city of San Clemente with a population of approximately 64,000 people<sup>74</sup>; and
- Approximately 247,000 people visiting the nearby beach area.

By contrast the radiological consequences of a dry cask rupture are significant less. According to the NRC's RASCAL Code a cask rupture would result in the release of 34,000 curies of radioactivity, with a total effect dose equivalent of 5.3 rems and 2.6 rems at 0.1 miles and 0.2 miles respectively. The thyroid dose would be 4 and 1.9 rems at the same respective distances. Thus, the radiological release from a pool fire at SONGs would be more than 2,500 times larger than a cask rupture. Doses within one mile from the pool fire would be nearly 1,000 times higher.

## **NRC's Response Regarding Spent Fuel Pools to the Fukushima Accident**

In July 2011 the NRC's taskforce assembled in response to the Fukushima Dai-Ichi nuclear disaster, issued several recommendations to upgrade safety at U.S. nuclear power stations.<sup>75</sup> Of the twelve recommendations, several specifically addressed spent fuel pools. The Task Force made it a top priority for reactor operators to:

- install safety-related instrumentation to monitor pool levels, temperature and radiation levels from the reactor control room;
- ensure there are reliable water make-up systems that are capable of withstanding earthquakes and floods
- Ensure pool cooling systems are powered by emergency back-up generators in case of the loss of off-site power.

By December 2011, the Commission approved the staff's recommendations for the prioritization and implementation of the Near-Term Task Force's recommendations, with some changes. Significantly, the Commission voted to reject a staff and Task force recommendation for all post Fukushima upgrades to be mandatory for "adequate protection" of the public under the Atomic Energy Act. The Commission only required that pool water level instrumentation be placed in reactor control rooms, while fending off any further spent fuel pools upgrades.

Conspicuous in its absence was any mention or discussion in the aftermath of the Fukushima accident by the NRC of reducing the density of spent fuel pool storage, which is substantially greater at U.S. reactors than at the Fukushima site. For instance the two pools at SONGS hold a comparable amount of spent fuel as the four damaged reactors at the Fukushima site.<sup>76</sup> Underscoring the NRC's conflicting claims about spent fuel pool dangers, the U.S. District Court of Appeals vacated the NRC's "Waste Confidence Rule," found that the NRC had not provided adequate assurance regarding the safety of high-density spent fuel pools. According to the Court:

"We conclude that the Commission's EA [Environmental Assessment] and resulting FONSI [Finding of No Significant Impact] are not supported by substantial evidence on the record because the Commission failed to properly examine the risk of leaks in a forward-looking fashion and failed to examine the potential consequences of pool fires....

With full credit to the Commission's considerable enforcement and inspection efforts, merely pointing to the compliance program is in no way sufficient to support a scientific finding that spent-fuel pools will not cause a significant environment impact during the extended storage period... That past leaks have not been harmful with respect to groundwater does not speak to how future leaks might occur and what the effects of those leaks might be. The Commission's analysis of leaks, therefore, was insufficient."<sup>77</sup>

## The Collapse of the Disposal Framework

The framework of the 1982 Nuclear Waste Policy Act (NWPA) for ultimate disposal of high-level radioactive waste, one of the planet's most dangerous human-made substances, has collapsed. Several events are converging that pave the way to reopen this law. They include:

- Abandonment of the proposed Yucca Mountain high-level radioactive waste geologic disposal site underscored by the 2012 elections;
- Recommendations of the Blue Ribbon Commission on America's Nuclear Future (BRC). The panel, convened in 2010 by President Obama after cancelling the Yucca Mt. project, calls for a major institutional overhaul of storage and disposal site selection expected to take several decades to implement if adopted;
- Rejection of the U.S. Nuclear Regulatory Commission's Waste Confidence Rule by the Federal Appeals Court of the District of Columbia for failure to thoroughly evaluate the environmental, safety and health impacts from spent nuclear fuel storage, as a result of an uncertain disposal future;
- Maximum high-density spent fuel pool storage capacity reached by all operating U.S. power reactors by 2015; and
- Economic impacts from cheap abundant natural gas on aged nuclear power stations vulnerable to increased expenses associated with expanded dry storage of spent fuel.

After the Obama administration cancelled the Yucca Mt. project a Presidential Blue Ribbon Commission on America's Nuclear Future was tasked with coming to terms with the country's five-decade-plus quest to store and dispose of its high-level radioactive waste. In January 2012, the Panel recommended, among other things:

- development of a "new consent-based process... for selecting and evaluating sites and licensing consolidated storage and disposal facilities in the future:"
- establishment of "a new waste management organization" to replace the role of the Energy Department with "a new independent, government- chartered corporation..."

The bottom line is that optimally, these recommendations will take several decades before consolidated storage and disposal can occur.

### Going dry for safety

To reduce such safety hazards at SONGS and all other U.S. reactor stations, operators should take steps to store all spent fuel that is more than five years old in dry, hardened storage containers. The casks used in dry storage systems are designed to resist floods, tornadoes, projectiles, fires and other temperature extremes, and other unusual scenarios. A cask typically consists of a sealed metal cylinder that provides leak-tight containment of the spent fuel. Each cylinder is surrounded by additional steel, concrete, or other material to provide radiation shielding to workers and everyone else.

SONGS already has a cask fabrication infrastructure capable of gearing up to thin out its high density pools.

Casks can be placed horizontally or set vertically on a concrete pad, with each assembly being exposed to an open channel on at least one side to allow for greater air convection to carry away heat. In hardened dry-cask storage—the safest available design for such systems—the casks are enclosed in a concrete bunker underground.

Installing emergency spray cooling systems that can survive earthquake and flooding, while making advance preparations for repairing holes in spent-fuel pool walls on an emergency basis, should be undertaken. The German nuclear industry took these same steps 25 years ago, after several jet crashes and terrorist acts at nonnuclear locations.

The National Academy of Sciences has concluded that dry-cask storage offered several advantages over pool storage. Dry-cask storage is a passive system that relies on natural air circulation for cooling, rather than requiring water to be continually pumped into cooling pools to replace water lost to evaporation caused by the hot spent fuel. Also, dry-cask storage divides the inventory of spent fuel among a large number of discrete, robust containers, rather than concentrating it in a relatively small number of pools.

Despite the major damage caused by the earthquake and tsunami at the Fukushima Da-Ichi nuclear site, nine dry casks holding 408 spent nuclear fuel assemblies were unscathed.

Yet today, only 25% of the spent fuel at SONGS and most other U.S. reactors are stored in such systems, and the NRC has not taken strong steps to encourage their use. Nuclear reactor owners use dry casks only when there is no longer enough room to put the waste in spent-fuel pools. Without a shift in NRC policy, reactor pools will still hold enormous amounts of radioactivity, far more than provided for in the original designs, for decades to come.

There is money at hand to accomplish these important safety improvements. In our 2003 study, we estimated that the removal of spent fuel older than five years could be accomplished with existing cask technology in 10 years and at a cost of \$3 billion to \$7 billion. The expense would add a marginal increase of approximately 0.4 to 0.8% to the retail price of nuclear-generated electricity.

In August 2012, the Electric Power Research Institute (EPRI) released its own analysis of the costs associated with our recommendations. EPRI concluded that the cost for the early transfer of spent fuel storage into dry storage would be \$3.6 billion—a level near the lower end of our estimates. This increase, EPRI said, would be “primarily related to the additional capital costs for new casks and construction costs for the dry storage facilities.”<sup>78</sup>

When EPRI’s assumptions are applied to SONGS, it will cost approximately \$122 million (each costing ~\$1 million) for labor, canister and overpack construction to place all remaining spent nuclear fuel into dry casks.<sup>79</sup> Annual operating costs for dry storage at a decommissioned reactor vary and are in the range of \$10 million per year.<sup>80</sup> Operating costs for pool storage at a decommissioned reactor site is estimated at about \$4.5 million per year.<sup>81</sup>

## Spent Fuel Pool Aging Concerns

Wet storage operating costs do not factor in potential safety problems associated with age and deterioration of spent fuel pool systems, especially at closed reactors. In 2011 a study done for the U.S. Nuclear regulatory Commission by the Oak Ridge National Laboratory concluded:

*“As nuclear plants age, degradations of spent fuel pools (SFPs), reactor refuelling cavities, and the torus structure of light-water reactor nuclear power plants (NPPs) are occurring at an increasing rate, primarily due to environment-related factors. During the last decade, a number of NPPs have experienced water leakage from the SFPs [spent fuel pools] and reactor refueling cavities.”<sup>82</sup>*

The authors of this report note that: *“it is often hard to assess their in situ condition because of accessibility problems.... Similarly, a portion of the listed concrete structures are either buried or form part of other structures or buildings, or their external surfaces are invisible because they are covered with liners.”<sup>83</sup>*

Of course, even though our estimates suggest that the added costs of moving to dry-cask storage will not be overly burdensome, individual reactor owners will need to pay them. Here is where the NRC can play a vital role by adopting policies that will allow for the costs of dry, hardened spent-fuel storage to be taken from the electricity rates paid by consumers of nuclear-generated electricity. The Nuclear Waste Policy Act established a user fee to pay 0.1 cent per kilowatt-hour to cover the search for and establishment of a high-level radioactive waste repository, but the law did not allow these funds to be used to enhance the safety of onsite spent fuel storage.

As of fiscal year 2011, only \$7.3 billion had been spent of the \$25.4 billion collected through user fees, leaving \$27 billion unspent. This sum could more than pay for the dry, hardened storage of spent reactor fuel older than five years at all reactors. Safely securing the spent fuel that is currently in crowded pools at reactors should be a public safety priority of the highest degree. The cost of fixing the nation’s nuclear vulnerabilities may be high, but the price of the status quo is far higher.

---

### NOTES

1 Robert Alvarez is a Senior Scholar at the Institute for Policy Studies in Washington D.C. and an Adjunct Professor at the Johns Hopkins School of Advanced International Studies. He is considered one of the nation’s foremost experts on civilian and military nuclear programs. Mr. Alvarez served as Senior Policy Advisor to the U.S. Secretary of Energy during the Clinton Administration, and prior to that was Chief Investigator for the U.S. Senate Committee on Governmental Affairs.

2 United States Government Accountability Office, Commercial Spent Nuclear Fuel, Observations and Key Attributes and Challenges of Storage and Disposal Options, GAO-13-53T, April 11, 2013, p. 1.  
<http://www.gao.gov/assets/660/653731.pdf>



---

3 See, <http://www.edison.com/pressroom/pr.asp?bu=&year=0&id=8143> and Edison notification to NRC June 12<sup>th</sup> 2013 - <http://www.songscommunity.com/docs/songscsensation.pdf>

4 Opening Statement of Senator Barbara Boxer "Hearing on the Nominations of Allison Macfarlane and Kristine Svinicki to be Members of the Nuclear Regulatory Commission" June 13, 2012.  
[http://epw.senate.gov/public/index.cfm?FuseAction=Hearings.Statement&Statement\\_ID=f5a8c4d6-fbd7-483f-8ed0-e6ae703baa0d](http://epw.senate.gov/public/index.cfm?FuseAction=Hearings.Statement&Statement_ID=f5a8c4d6-fbd7-483f-8ed0-e6ae703baa0d)

5 Frank von Hippel, The radiological and Psychological consequences of the Fukushima Dai-Ichi accident, Bulletin of Atomic Scientists, 2011 67:27, p. 29. [http://people.reed.edu/~ahm/Courses/Reed-POL-422-2012-S1\\_NP/Syllabus/EReadings/03.2/03.2.Hippel2011The-Radiological.pdf](http://people.reed.edu/~ahm/Courses/Reed-POL-422-2012-S1_NP/Syllabus/EReadings/03.2/03.2.Hippel2011The-Radiological.pdf)

6 The National Diet of Japan, The official report of The Fukushima Nuclear Accident Independent Investigation Commission, Executive Summary, July 2012. [http://www.nirs.org/fukushima/naic\\_report.pdf](http://www.nirs.org/fukushima/naic_report.pdf)

7 Union of Concerned Scientists, Nuclear Power Safety in California, May 2012.  
[http://www.ucsusa.org/assets/documents/nuclear\\_power/nuclear-power-safety-in-california.pdf](http://www.ucsusa.org/assets/documents/nuclear_power/nuclear-power-safety-in-california.pdf)

8 Ibid.

9 Nuclear Energy Institute, U.S. Spent Nuclear Fuel Data as of December 31, 2011.

10 Ibid.

11 U.S. Nuclear Regulatory Commission, Characteristics for the Representative Commercial Spent Fuel Assembly for Preclosure Normal Operations, May 2007, Table 16, p.44-45. (This estimate is relevant for SONGS Units 2 and 3, and is based on a burnup of 50,000 MWd/t and a decay time of 10 years)  
<http://pbadupws.nrc.gov/docs/ML0907/ML090770390.pdf>

12 U.S. Department of Energy, Final Environmental Impact Statement for a Geologic Repository for the Disposal of Spent Nuclear Fuel and High-Level Radioactive Waste at Yucca Mountain, Nye County, Nevada, DOE/EIS-0250, February 2002, Appendix A, Table A-9, P. A-17 (This estimate is relevant for SONGS Unit 1, and is based on a burnup of 41,200 MWd/t and a decay time of 23 years).

13 National Research Council, Committee on the Management of Certain Radioactive Waste Streams Stored in tanks at Three Department of Energy Sites, National Academies Press (2006), P. 3.  
[http://www.nap.edu/catalog.php?record\\_id=11618#toc](http://www.nap.edu/catalog.php?record_id=11618#toc)

14 South California Edison, San Onofre Nuclear Generating Station Units 2 and 3, Spent Fuel Dilution Analysis. December 2001.pp-3-16. <http://pbadupws.nrc.gov/docs/ML0206/ML020640585.pdf>

15 Op Cit. Ref. 5.

16 U.S. Department of Energy, Argonne National Laboratory, Nuclear Fuel, April 2011.

17 Graham Sharpless, CD and DVD Disc Manufacturing, Deluxe Global Media Services Ltd., July 2003.p 3.  
[http://cddvdreplications.com/help/technology/downloads/tech\\_docs/replication.pdf](http://cddvdreplications.com/help/technology/downloads/tech_docs/replication.pdf)

18 Desmond Fraser, Electromagnetic Engineering and Aluminum Foil, Rheintech Laboratories, Inc., August 3, 2011.  
<http://www.rheintech.com/blog/archives/884>

19 Op Cit Ref 5.

---

20 International Atomic Energy Agency, Impact of High Burnup Uranium Oxide and Mixed Uranium Plutonium Oxide Water Reactor Fuel on Spent Fuel Management, IAEA Nuclear Energy Series, No. NF-T-3.8, Vienna, (2011). P. 6, /MTC/CD/Publications/PDF/Pub1490\_web.pdf

21 International Panel on Fissile Materials, Managing Spent Fuel from Nuclear Power Reactors, September 2011, P. 7, Fig. 1-41-4. <http://www.princeton.edu/sgs/publications/ipfm/Managing-Spent-Fuel-Sept-2011.pdf>

22 Ibid.

23 National Research Council, Board on Radiation Effects, Division of Earth and Life Studies, Committee to Assess Health Risks from Exposure to Low Levels of Ionizing Radiation, Health Risks from Exposure to Low Levels of Ionizing Radiation BEIR VII, Phase II, National Academies Press, (2006), P. 96 Table 4-1. [https://download.nap.edu/openbook.php?record\\_id=11340&page=1](https://download.nap.edu/openbook.php?record_id=11340&page=1)

24 National Council on Radiation Protection and Measurements, Cesium-137 in the Environment: Radioecology and Approaches to Assessment and Management, NCRP Report No. 154, November 2006, p.1.

25 Op Cit Ref 9, Table 3-1, p. 52.

26 U.S. Nuclear Regulatory Commission, Safety Evaluation by the Office of Nuclear Safety Regulation Related to Amendment No. 131 to Facility Operating License No. NPF-10 and Amendment 120 to Facility Operating License No. NPF-15, Docket Nos. 50-361 and 50-362, October 1996, P. 6. <http://pbadupws.nrc.gov/docs/ML0220/ML022000232.pdf>

27 Op Cit Ref. 4.

28 National Research Council, Board on Radioactive Waste Management, Committee on the Safety and Security of Commercial Spent Nuclear Fuel Storage, National Academies Press (2006), p. 38-39. [http://www.nap.edu/openbook.php?record\\_id=11263&page=38](http://www.nap.edu/openbook.php?record_id=11263&page=38), [http://www.nap.edu/openbook.php?record\\_id=11263&page=39](http://www.nap.edu/openbook.php?record_id=11263&page=39)

29 U.S. Nuclear regulatory Commission, Technical Study of Spent Fuel Pool Accident Risk at Decommissioning Nuclear Power Plants, October 2000, P. ix. <http://pbadupws.nrc.gov/docs/ML0104/ML010430066.pdf>

30 R. Wigeland, T. Taiwo, M. Todosow, W. Halsey, J. Gehin, Options Study – Phase II, Department of Energy, Idaho National Laboratory, INL/EXT-10-20439, September 2010. <http://www.inl.gov/technicalpublications/Documents/4781584.pdf>

31 U.S. Department of Energy, Office of Civilian Radioactive Waste Management, Yucca Mountain Science and Engineering Report Rev. 1, Technical Information Supporting Site Recommendation Consideration, Report DOE/RW-0539-1 (North Las Vegas, NV: U.S. DOE, 2002).

32 National Academy of Engineering, Managing Nuclear Waste, Summer 2012, pp 21, 31. <http://www.nae.edu/File.aspx?id=60739>

33 Erik Kolstad, Nuclear Fuel Behavior in Operational Conditions and Reliability, Prepared for IPG meeting-Workshop on Fuel Behavior, Argonne National Laboratory, September 2008, p. 10

34 U.S. Nuclear Regulatory Commission, Southern California Edison San Onofre Nuclear Generating Station, Units 2 and 3, Issuance of Amendment for San Onofre Nuclear Generating Station, Unit No 2 and 3, October, 3, 1996. <http://pbadupws.nrc.gov/docs/ML0220/ML022000232.pdf>

35 U.S. Nuclear Regulatory Commission, Standard Review Plan for Spent Fuel Dry Storage Facilities, Final Report NUREG-1567, March 2000. P. 6-15. <http://www.nrc.gov/reading-rm/doc-collections/nuregs/staff/sr1567/sr1567.pdf>

36 U.S. Nuclear Regulatory Commission, Rulemaking Issue, Notation Vote, Memorandum from: R.W. Borchardt, Executive Director for Operations, Subject: Proposed Rulemaking – 10CFR 50.46c Emergency Core Cooling System

---

Performance During Loss-of-Coolant Accidents (RIN 3150-AH42), SECY-12-0034, March 1, 2012, p. 2.  
<http://www.nrc.gov/reading-rm/doc-collections/commission/secys/2012/2012-0034scy.pdf>

37 Op Cit. Ref. 27. P 45

38 Ibid.

39 Ibid

40 International Atomic Energy Agency, Impact of High-Burnup Uranium Oxide and Mixed Uranium – Plutonium Oxide Water Reactor Fuel on Spent Fuel Management, IAEA Nuclear Energy Series, No.. NF-T-3.8, June 2011. P. 39.  
[http://www-pub.iaea.org/MTCD/Publications/PDF/Pub1490\\_web.pdf](http://www-pub.iaea.org/MTCD/Publications/PDF/Pub1490_web.pdf)

41 Ibid.

42 Ibid. p.69.

43 Ibid p. 51.

44 Ibid. p.1.

45 Zhiwen Xu, Mujid S. Kazimi and Michael Driscoll, Impact of High Burnup on PWR Spent Fuel Characteristics, Nuclear Science and Engineering, 151, 261-273 (2005), <http://ocw.internet-institute.eu/courses/nuclear-engineering/22-251-systems-analysis-of-the-nuclear-fuel-cycle-fall-2005/readings/impact.pdf>

46 EPRI Fuel Reliability Executive Committee Meeting Dallas, USA, January 23, 2008, J. Deshon, A. Kucuk - EPRI Fuel Reliability Program

47 Ibid.

48 U.S. Nuclear Regulatory Commission, Memorandum, Licensee: South California Edison Company, Facility: San Onofre Generating Station Units 2 and 3, Subject: Summary of January 12, 2011, Meeting with Southern California Edison Company on Planned Licensing Actions to Allow AREVA Fuel at the San Onofre Nuclear Generating Station, Units 2 and 3 (Tac. Nos. ME5288 and ME5289), February 9, 2011.  
<http://pbadupws.nrc.gov/docs/ML1103/ML110350199.pdf>

49 South California Edison, San Onofre Nuclear Generating Station (SONGS), License Amendment Request to Support Use of AREVA Nuclear Fuel, January 12, 2011, p. 5. <http://pbadupws.nrc.gov/docs/ML1101/ML110120630.pdf>

50 Ibid.

51 U.S. Nuclear Regulatory Commission, Spent Fuel Storage Facility Design Basis, Regulatory Guide 1.13, Rev. 2, March 2007.p. 5. <http://www.nrc.gov/reading-rm/doc-collections/reg-guides/power-reactors/rg/01-013/01-013.pdf>

52 Op Cit Ref 11.

53 Southern California Edison, Letter to the U.S. Nuclear Regulatory Commission, Subject: Docket Nos. 50-361 and 50-362, LER 2010-005-00, Refueling Water Storage Tank Alignment to Non-Seismic Purification Loop Results in Potential Loss of Safety Function, December 10, 2010. <http://pbadupws.nrc.gov/docs/ML1034/ML103480104.pdf>

54 Robert Alvarez, What about spent fuel?”, Bulletin of Atomic Scientists, Vol. 58, No. 1, pp. 45-47.  
<http://www.nirs.org/radwaste/atreactorstorage/alfvarezarticle2002.pdf>

55 Southern California Edison, Letter to the U.S. Nuclear Regulatory Commission, Docket No. 50-631, License Event Report No. 2009-004, February 19, 2009. <http://pbadupws.nrc.gov/docs/ML1006/ML100610562.pdf>

---

56 U.S. Nuclear Regulatory Commission, Regulatory Guide 1.27 , Office of Standards Development, Revision 2, January 1976. <http://pbadupws.nrc.gov/docs/ML0037/ML003739969.pdf>

57 U.S. NRC, Office of Nuclear Reactor Regulation, On Site Spent Fuel Criticality Analyses, NRR Action Plan, May 21, 2010. <http://pbadupws.nrc.gov/docs/ML1015/ML101520463.pdf>

58 South California Edison, Letter to the NU.S. Nuclear regulatory Commission, Subject: Docket Nos. 50-361 and 50-362 Amendment Application Numbers 243, Supplement 1 and 227, Supplement 1 Proposed Change Number (PCN)566, Revision 1, Request to Revise Fuel Storage Pool Boron Concentration, San Onofre Nuclear Generating Station Units 2 and 3, June 15, 2007, Enclosure 2,p. 2. <http://pbadupws.nrc.gov/docs/ML0717/ML071700097.pdf>

59 Ibid.

60 U.S. Nuclear Regulatory Commission, Region IV, Letter to Mr. Peter Deitrich, Senior Vice President, Southern California Edison, May 20, 2011, Subject: San Onofre Nuclear Generating Station – Independent Spent Fuel Storage Installation (ISFSI) Inspection Report 050-206/2011-011;050-361/2011;050/362/2011;072-041/2011-001, May 20, 2011. <http://adamswebsearch2.nrc.gov/webSearch2/doccontent.jsp?doc={95DE9407-9EE9-400E-814C-2E2068C1338B}>

61 Op Cit. Ref. 8.

62 Op Cit Ref 55, p. 11.

63 Op Cit Ref. 55. P. 23.

64 Op Cit. Ref. 55. P. 32.

65 V.L Sailor, K.R. Perkins, J.R. Weeks, H.R. Connell, Severe Accidents in Spent Fuel Pools in Support of Generic Safety Issue 82, Brookhaven National Laboratory, NUREG/CR-4982, June 1987.

66 Robert Alvarez, Jan Beyea, Klaus Janberg, Jungmin Kang, Ed Lyman, Allison Macfarlane, Gordon Thompson and Frank N. von Hippel, Reducing the Hazards from Stored Spent Power-Reactor Fuel in the United States, Science and Global Security, 11:1-51, 2003.

67 Op. cit. ref. 21.

68 National Research Council, Committee on the Safety and Security of Commercial Spent Nuclear Fuel Storage, Board on Radioactive Waste Management, The National Academies Press, Washington D.C. (2006), pp. 49, 35, and 50.

69 Shankar Vedantam, Storage of Nuclear Spent Fuel Criticized: Science Academy Study Points to Risk of Attack, Washington Post, March 28, 2005.

70 U.S. Nuclear Regulatory Commission, Office of Nuclear Security and Incidence Response, RASCAL 3.0.5 Descriptions of Models and Methods, NUREG-1887, August 2007. <http://www.nrc.gov/reading-rm/doc-collections/nuregs/staff/sr1887/sr1887.pdf>

71 U.S. Nuclear Regulatory Commission, Office of Nuclear Security and Incidence Response, RASCAL 3.0.05 Workbook, NUREG-1889,September 2007, p. 126. <http://pbadupws.nrc.gov/docs/ML0729/ML072970068.pdf>

72 National Council On Radiation Protection and Measurements, Cesium-137 in the Environment, Publication No. 154, September 2006, Table 3.1, P. 52.

73 Tiffany Hsu, Dunkin' Donuts coming to Camp Pendleton, Los Angeles Times, February 29, 2012. <http://articles.latimes.com/2012/feb/29/business/la-fi-mo-dunkin-donuts-camp-pendleton-20120229>

---

74 U.S. Census Bureau.

[http://www.google.com/publicdata/explore?ds=kf7tgg1uo9ude\\_&met\\_y=population&idim=place:0665084&dl=en&hl=en&q=san+clemente+population](http://www.google.com/publicdata/explore?ds=kf7tgg1uo9ude_&met_y=population&idim=place:0665084&dl=en&hl=en&q=san+clemente+population)

75 U.S. Nuclear Regulatory Commission, The Near-Term Task Force Review of Insights from the Fukushima Da-Ichi Accident, Recommendations for Enhancing Reactor Safety in the 21<sup>st</sup> Century, July 2011.

<http://pbadupws.nrc.gov/docs/ML1118/ML111861807.pdf>

76 Koji Shirai and Toshiari Saegusa, Central Research Institute of the Electric Power Industry (CRIEPI), Impact of Fukushima Accident on Spent Fuel Management in Japan, January 31, 2012. (The four reactors at the Fukushima Dai-ichi site hold 2,534 assemblies, while SONGs two pools hold 2, 496 assemblies.)

[http://www.inmm.org/AM/Template.cfm?Section=Past\\_Events&Template=/CM/ContentDisplay.cfm&ContentID=2917](http://www.inmm.org/AM/Template.cfm?Section=Past_Events&Template=/CM/ContentDisplay.cfm&ContentID=2917)

77 United States Court of Appeals for the District of Columbia, Nuclear Regulatory Commission V. State of New Jersey, ET, AL., No.11-1045, Decided June 8, 2012.

[http://www.cadc.uscourts.gov/internet/opinions.nsf/57ACA94A8FFAD8AF85257A1700502AA4/\\$file/11-1045-1377720.pdf](http://www.cadc.uscourts.gov/internet/opinions.nsf/57ACA94A8FFAD8AF85257A1700502AA4/$file/11-1045-1377720.pdf)

78 E. Supko, Impacts Associated with Transfer of Spent Nuclear Fuel from Spent Storage Pools to Dry Storage After Five Years of Cooling Rev 1, Electric Power Research Institute (EPRI), August 2012 p. vii.

79 Ibid.

80 U.S. Government Accountability Office, Nuclear Waste Management: Key Attributes, Challenges, and Costs for the Yucca Mountain Repository and Two Potential Alternatives, GAO 10-48, November 2009. P. 55.

<http://www.gao.gov/new.items/d1048.pdf>

81 Ibid.

82 U.S. Nuclear regulatory Commission, A summary of Aging Effects and Their Management in Reactor Spent Fuel Pools, Refueling Cavities, TORI and Safety-Related Concrete Structures, NUREG/CR-7111 (2011). P. vxiii.

<http://pbadupws.nrc.gov/docs/ML1204/ML12047A184.pdf>

83 Ibid.